



2.5" SATA III SLC SSD  
Supports Fast & Secure Erase  
BON-II Series

**Product Specification**

INDUSTRIAL

APRO RUGGED METAL 2.5" SATA III SLC SSD

SUPPORTS FAST / SECURE ERASE

Version 01V1

Document No. 100-xR2SRBON-JHTS

JUNE 2014

**APRO CO., LTD.**

Phone: +88628226-1539

Fax: +88628226-1389

This document is for information use only and is **subject to change without prior notice**. APRO Co., Ltd. assumes no responsibility for any errors that may appear in this document, nor for incidental or consequential damages resulting from the furnishing, performance or use of this material. No part of this document may be reproduced, transmitted, transcribed, stored in a retrievable manner or translated into any language or computer language, in any form or by any means, electronic, mechanical, magnetic, optical, chemical, manual or otherwise, without the prior written consent of an officer of APRO Co., Ltd.

All parts of the APRO documentation are protected by copyright law and all rights are reserved.

APRO and the APRO logo are registered trademarks of APRO Co., Ltd.

Product names mentioned herein are for identification purposes only and may be trademarks and/or registered trademarks of their respective companies.

© 2014 APRO Corporation. All rights reserved.

#### Revision History

<b>Revision</b>	<b>Description</b>	<b>Date</b>
1.0	Initial release	2014/06/27
1.1	Adding FE/SE Jumper in block diagram	2014/12/02

# CONTENTS

<b>1.</b>	<b>INTRODUCTION.....</b>	<b>- 3 -</b>
1.1.	SCOPE.....	- 4 -
1.2.	SYSTEM FEATURES.....	- 4 -
1.3.	FLASH MANAGEMENT TECHNOLOGY - STATIC WEAR LEVELING.....	- 4 -
1.4.	DRAM BUFFER.....	- 5 -
1.5.	POWER INTERRUPT DATA PROTECTION TECHNOLOGY .....	- 5 -
<b>2.</b>	<b>PRODUCT SPECIFICATIONS.....</b>	<b>- 6 -</b>
2.1.	SYSTEM ENVIRONMENTAL SPECIFICATIONS.....	- 6 -
2.2.	SYSTEM POWER REQUIREMENTS.....	- 6 -
2.3.	SYSTEM PERFORMANCE.....	- 6 -
2.4.	SYSTEM RELIABILITY .....	- 7 -
2.5.	PHYSICAL SPECIFICATIONS .....	- 7 -
2.5.1.	Conformal coating.....	- 9 -
<b>3.</b>	<b>INTERFACE DESCRIPTION.....</b>	<b>- 9 -</b>
3.1.	APRO RUGGED METAL 2.5" SATA III SLC SSD INTERFACE.....	- 9 -
3.2.	PIN ASSIGNMENTS .....	- 10 -
<b>4.</b>	<b>CONFIGURATION OF BON-II SERIES 2.5" SATA III SLC SSD.....</b>	<b>- 11 -</b>
4.1.	FAST / SECURE ERASE JUMPER .....	- 11 -
4.1.1.	Default Setting.....	- 11 -
4.1.2.	Write Protect Function .....	- 11 -
4.1.3.	Fast Erase.....	- 12 -
4.1.4.	Secure Erase.....	- 12 -
4.2.	AUTO-RESUME FEATURES .....	- 13 -
4.3.	RANDOM DATA WRITTEN DURING THE SANITIZE PROCEDURE .....	- 13 -
4.4.	PROTECTION MECHANISM .....	- 13 -
4.5.	USING THE SSD AFTER SANITIZING PROCEDURE .....	- 13 -
<b>5.</b>	<b>SOFTWARE COMMANDS .....</b>	<b>- 14 -</b>
5.1.	WRITE PROTECT.....	- 14 -
5.1.1.	Inputs for Enabling Write Protect.....	- 14 -
5.1.2.	Inputs for Disabling Write Protect.....	- 15 -
5.2.	FAST ERASE .....	- 16 -
5.2.1.	Inputs for Enabling Fast Erase.....	- 16 -

---

5.2.2. **Outputs for Enabling Fast Erase** ..... - 16 -

5.3. **SECURE ERASE**..... - 17 -

5.3.1. **Identify Device Table** ..... - 17 -

5.3.2. **NSA Manual 130-2**..... - 18 -

5.3.3. **USA-AF AFFSI 5020**..... - 19 -

5.3.4. **DoD 5220.22-M**..... - 20 -

5.3.5. **IRIG 106**..... - 21 -

5.3.6. **USA Navy NAVSO P-5239-26** ..... - 22 -

5.3.7. **USA-Army 380-19**..... - 23 -

5.3.8. **NISPOMSUP Chap 8, Sect. 8-501**..... - 24 -

5.3.9. **NSA Manual 9-12**..... - 25 -

6. **REQUIRED TIME FOR SECURE ERASE FUNCTION**..... - 26 -

**APPENDIX A: ORDERING INFORMATION** ..... - 27 -

1. **PART NUMBER LIST**..... - 27 -

2. **PART NUMBER DECODER:**..... - 27 -

**APPENDIX B: LIMITED WARRANTY**.....28

**1. Introduction**

APRO industrial rugged metal 2.5" SATA III SLC SSD – BON-II series provides high capacity flash memory Solid State Drive (SSD) that electrically complies with Serial ATA 3.0 (SATA) standard. APRO Rugged Metal 2.5" SATA III SLC SSD – BON-II Series support SATA Gen-III (6.0 GB/s) with high performance. The main used flash memories are SLC-NAND type flash memory chips. The available disk capacities are 8GB, 16GB, 32GB, 64GB, 128GB and 256GB.

The operating temperature grade is optional for Standard grade 0°C ~ 70°C and wide temp grade supports -40°C ~ +85°C. The data transfer performance by sequential read is up to 523.7 MB/sec, and sequential write is up to 371.9 MB/sec.

APRO Rugged Metal 2.5" SATA III SLC SSD – BON-II Series supports Fast Erase/Secure Erase which initiates by hardware design and software vendor commands. Fast Erase Procedure is one of the defaults sanitizing procedure in BON-II Series. Fast Erase enables users to erase entire disk contents within seconds; 8GB SSD needs about 6 seconds, and 128GB needs about 60 seconds to run the fast erase procedure for whole disk completely.

APRO Rugged Metal 2.5" SATA III SLC SSD built-in DDRIII 2Gbits SDRAM products provide a high level interface to the host computer. This interface allows a host computer to issue commands to the Rugged Metal 2.5" SATA III SLC SSD to read or write blocks of memory. Each sector is protected by a powerful 40 bits per 1024 bytes error correction (ECC). APRO Rugged Metal 2.5" SATA III SLC SSD BON-II Series intelligent controller manages interface protocols, data storage and retrieval as well as ECC, defect handling and diagnostics, power management and clock control.

Figure 1 shows a block diagram of the used high tech Rugged Metal 2.5" SATA III SLC SSD controller.

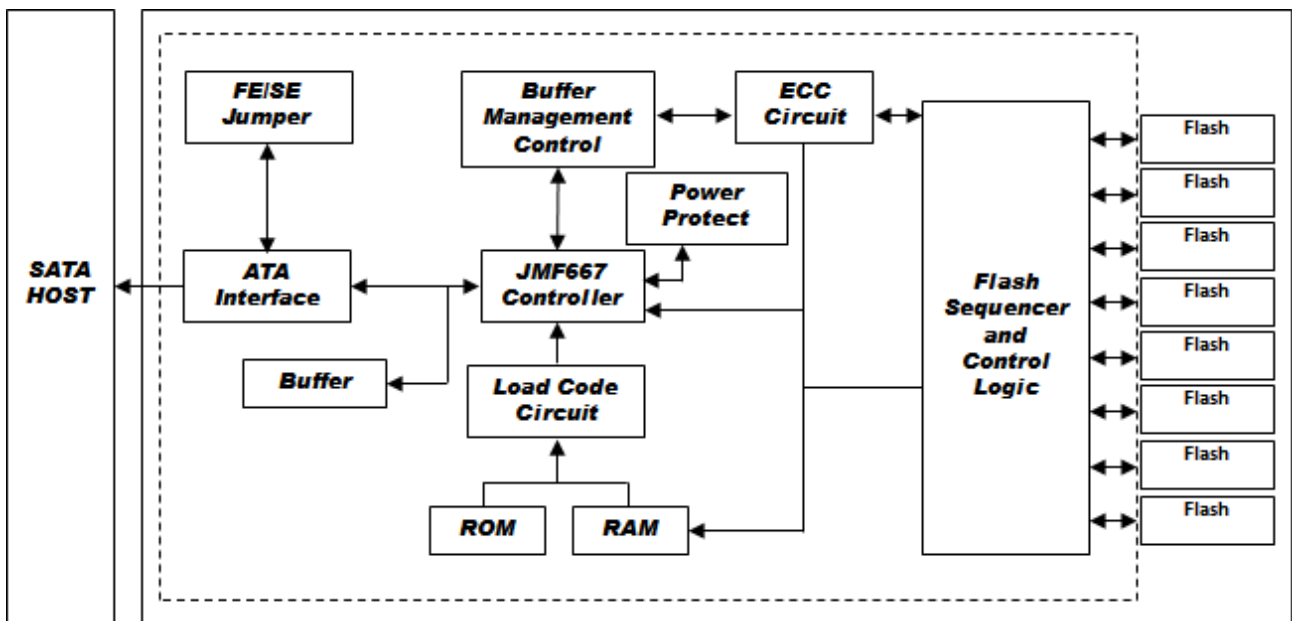

**Figure 1: APRO Rugged Metal 2.5" SATA III SLC SSD BON-II Series controller block diagram**

### 1.1. **Scope**

This document describes features, specifications and installation guide of APRO's Rugged Metal 2.5" SATA III SLC SSDs BON-II Series. In the appendix, there provides order information, warranty policy, RMA/DOA procedure for the most convenient reference.

### 1.2. **System Features**

- SLC-NAND type flash technology.
- Standard 2.5" SATA Flash Disk form-factor (9.5mm height).
- SATA 7-pin (data) + 15-pin (power connector) SATA Interface.
- Extremely Rugged Metal casing to endure harsh environments.
- Power interrupt data protection technology by Tantalum Capacitors.
- Fast Erase/Secure Erase by Hardware jumper setting located on the front side of SSD (J1/Pin-1&Pin-2) and by Software Vendor Commands.
- Supports hardware jumper setting for Write Protect function.
- SATA 1.0a, SATA 2.6 and SATA 3.0 specification compliance.
- SMART (Self-Monitoring, Analysis and Reporting Technology) function supported.
- Supports Window-7 TRIM Command.
- Non-volatile memory and no moving parts.
- SLC Flash SSD standard grade capacity from 8GB up to 256GB.
- Supports 2GBits DDRIII SDRAM Cache
- Sequential read performance up to 523.7 MB/sec.
- Sequential write performance up to 371.9 MB/sec.
- Automatic 40 bits per 1024 bytes error correction (ECC) and retry capabilities.
- +5 V  $\pm 5\%$  operation.
- Shock: 0.5ms, 1500 G, 3 axes.
- Vibration: 7 Hz to 2K Hz, 20G, 3 axes.
- Very high performance, very low power consumption.

### 1.3. **Flash Management Technology - Static Wear Leveling**

In order to gain the best management for flash memory, APRO 2.5" SATA III SLC SSD BON-II Series supports Static Wear-leveling technology to manage the Flash system. The life of flash memory is limited; the management is to increase the life of the flash product.

A static wear-leveling algorithm evenly distributes data over an entire Flash cell array and searches for the least used physical blocks. The identified low cycled sectors are used to write the data to those locations. If blocks are empty, the write occurs normally. If blocks contain static data, it moves that data to a more heavily used location before it moves the newly written data. The static wear leveling maximizes effective endurance Flash array compared to no wear leveling or dynamic wear leveling.

### **1.4. DRAM Buffer**

SSDs designed with a DDRIII SDRAM buffer which is support high transfer rate as a data buffer for the SSD; SSD with SDRAM buffer is able to deliver excellent random data transfer speed.

### **1.5. Power Interrupt Data Protection Technology**

In the event of an unstable power supply, SSD loses power before it can finish programming process from host to flash, this may cause data being written to the incorrect block and further leads to data corruption.

Power Interrupt Data Protection Technology is applied with several tantalum capacitors to provide power buffering after host power interruption. The Data Protection Technology provides enough time for the SSD controller can write all DRAM buffer data to flash, all data will be protected and without data loss.

The ability of Power Interrupt Data Protection Technology is able to write 1.28MB of data within 60ms.

This ensures all data in the DRAM buffer can be successfully written into flash.

Traditionally, super capacitors were applied in most SSD products, the advantages of tantalum capacitors over super capacitors are:

➤ **Tantalum capacitors are electrolyte free.**

It is able to maintain its designed capacitance for several years when used within design limits.

➤ **Wide operating temperature range.**

Tantalum capacitors can operate from temperature range of -55C to +125C, which is very suitable for industrial and military usage.

➤ **Tantalum capacitors have an ultimate high volumetric efficiency (CV/cc).**

For example, a 50-microfarad tantalum capacitor can be equal and to properly replace a 500-microfarad aluminum capacitor.

## 2. Product Specifications

For all the following specifications, values are defined at ambient temperature and nominal supply voltage unless otherwise stated.

### 2.1. System Environmental Specifications

Table 1: Environmental Specification

APRO Rugged Metal 2.5" SATA III SLC SSD		Standard Grade	Industrial Grade
BON-II Series		SR2SRxxxG-JHCTC-UFE(USE)	WR2SRxxxG-JHITI-UFE(USE)
Temperature	Operating:	0°C ~ +70°C	-40°C ~ +85°C
	Non-operating:	-20°C ~ +80°C	-50°C ~ +95°C
Humidity	Operating & Non-operating:	10% ~ 95% non-condensing	
Vibration	Operating & Non-operating:	7 Hz to 2K Hz, 20G, 3 axes	
Shock	Operating & Non-operating:	0.5ms, 1500 G, 3 axes	

### 2.2. System Power Requirements

Table 2: Power Requirement

APRO Rugged Metal 2.5" SATA III SLC SSD		Standard Grade
BON-II Series		SR2SRxxxG-JHCTC-UFE(USE)
DC Input Voltage (VCC) 100mV max. ripple(p-p)		5V±5%
+5V Current (Maximum average value)	Reading Mode :	460 (max.)
	Writing Mode :	650 (max.)
	Idle Mode :	190 (max.)

### 2.3. System Performance

Table 3: System Performances

Data Transfer Mode supporting		Serial ATA Gen-III (6.0Gb/s = 768MB/s)					
Average Access Time		0.1 ms (estimated)					
Maximum Performance	Capacity	8GB	16GB	32GB	64GB	128GB	256GB
	Sequential Read (MB/s)	449.5	423.7	485.8	523.7	498.7	523.7
	Sequential Write(MB/s)	123.4	132.2	240.5	365.2	367.7	371.9

Note:

(1). All values quoted are typically at 25°C and nominal supply voltage.

(2). Testing base on CrystalDiskMark 3.01 with file size 1000MB



## 2.4. System Reliability

**Table 4: System Reliability**

<b>Wear-leveling Algorithms</b>	Static Wear-leveling
<b>Bad Blocks Management</b>	Supportive
<b>ECC Technology</b>	40 bits per 1024 bytes
<b>Endurance</b>	Un-limited Read Cycles Endurance Management enables five years minimal useful life
<b>Data Retention</b>	10 years

## 2.5. Physical Specifications

Refer to Table 5 and see Figure 2 for Rugged Metal 2.5" SATA III SLC SSD BON-II Series physical specifications and dimensions.

**Table 5: Physical Specifications of APRO Rugged Metal 2.5" SATA III SLC SSD-BON-II Series**

<b>Length:</b>	99.70 mm / 4.0 in
<b>Width:</b>	69.90 mm / 2.75 in
<b>Thickness:</b>	9.50 mm / 0.37 in
<b>Weight:</b>	115.00 g / 4.06 oz

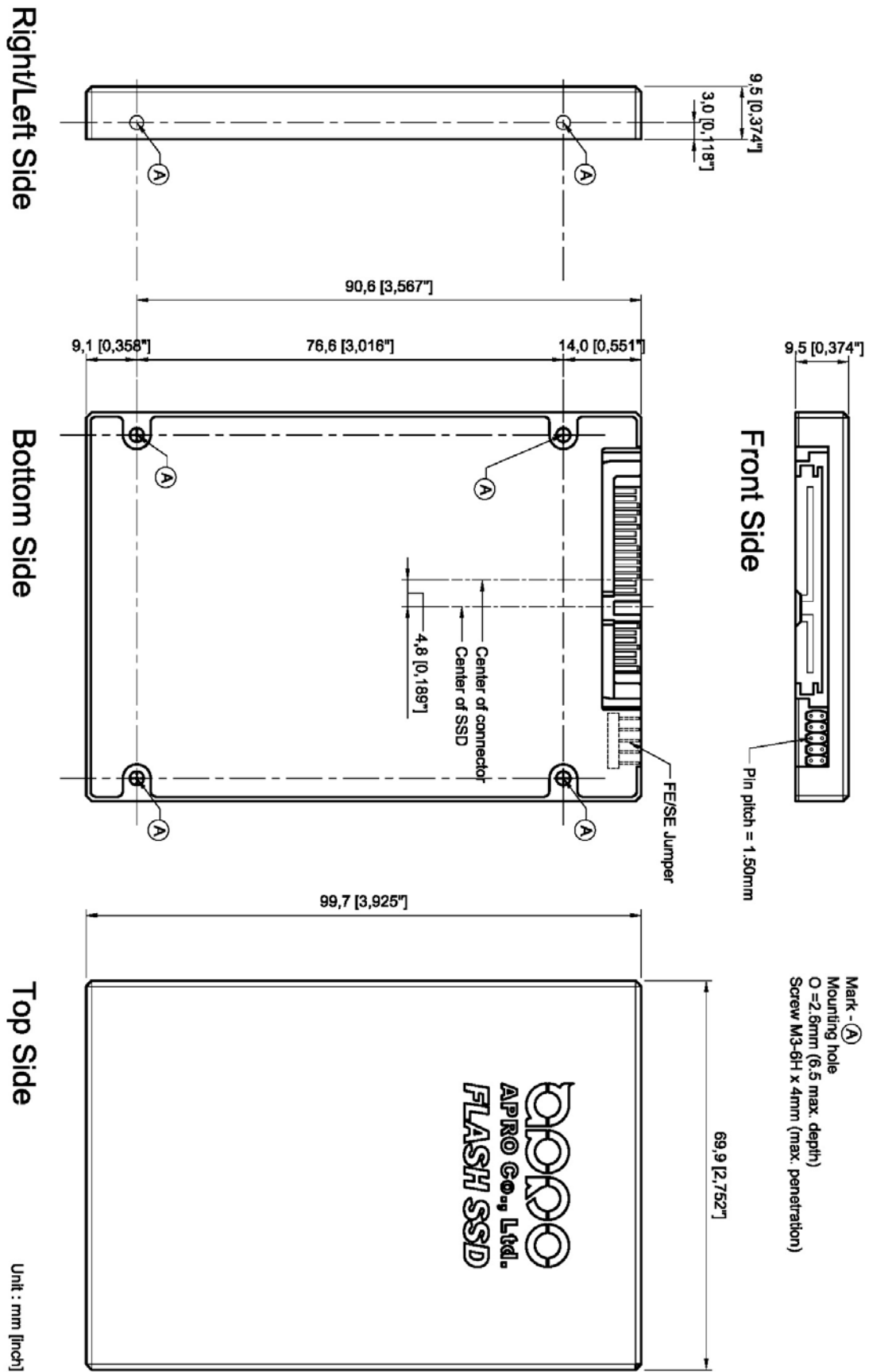

Figure 2: APRO Rugged Metal 2.5" SATA III SLC SSD Dimension

### 2.5.1. Conformal coating

Conformal coating is a protective, dielectric coating designed to conform to the surface of an assembled printed circuit board. Commonly used conformal coatings include silicone, acrylic, urethane and epoxy. APRO applies only silicone on APRO storage products upon requested especially by customers. The type of silicone coating features good thermal shock resistance due to flexibility. It is also easy to apply and repair.

Conformal coating offers protection of circuitry from moisture, fungus, dust and corrosion caused by extreme environments. It also prevents damage from those Flash storages handling during construction, installation and use, and reduces mechanical stress on components and protects from thermal shock. The greatest advantage of conformal coating is to allow greater component density due to increased dielectric strength between conductors.

APRO uses MIL-I-46058C silicon conformal coating

## 3. Interface Description

### 3.1. APRO Rugged Metal 2.5" SATA III SLC SSD interface

APRO Rugged Metal 2.5" SATA III SLC SSD is equipped with standard 7 pins + 15 pins Serial ATA connector.

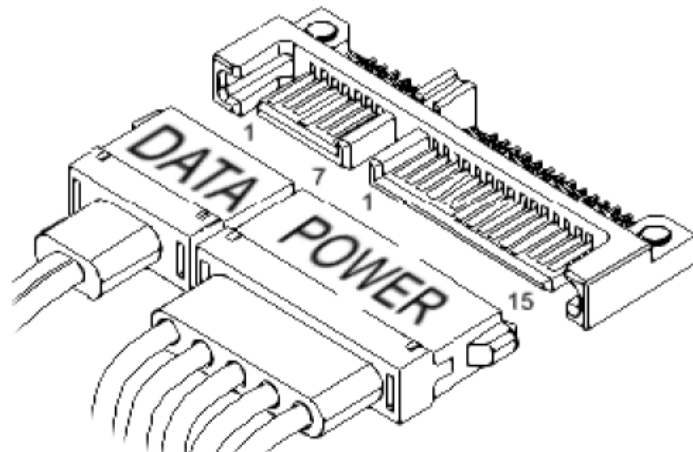

Figure 3 :The connectors of 2.5" SATA III SLC SSD

### 3.2. Pin Assignments

There are total of 7 pins in the signal segment and 15 pins in the power segment. The pin assignments are listed in below table 6.

**Table 6 - Pin Assignments**

Name	Type	Description
S1	GND	NA
S2	A+	Differential Signal Pair A
S3	A-	
S4	GND	NA
S5	B-	Differential Signal Pair B
S6	B+	
S7	GND	NA

Key and Spacing separate signal and power segments		
P1	NC	NA
P2	NC	NA
P3	NC	NA
P4	GND	NA
P5	GND	NA
P6	GND	NA
P7	V5	5V Power, Pre-Charge
P8	V5	5V Power
P9	V5	5V Power
P10	GND	NA
P11	DAS/DSS	Device Activity Signal / Disable Staggered Spin up
P12	GND	NA
P13	NC	NA
P14	NC	NA
P15	NC	NA

Notes:

1. All pins are in a signal row with a 1.27 mm (0.050" pitch).
2. The commands on the mating sequence in forward table apply to the case of backplane blind mate connector only. In this case, the mating sequences are:
  - (1) The pre-charge power pins and other ground pins.
  - (2) The signal pins and the rest of the power pins.

## 4. Configuration of BON-II Series 2.5" SATA III SLC SSD

### 4.1. Fast / Secure Erase Jumper

BON-II Series 2.5" SATA III SSD has several security features, such as fast erase, secure erase and a newly added write-protect function. These functions can be triggered by different hardware jumper settings or by ATA commands.

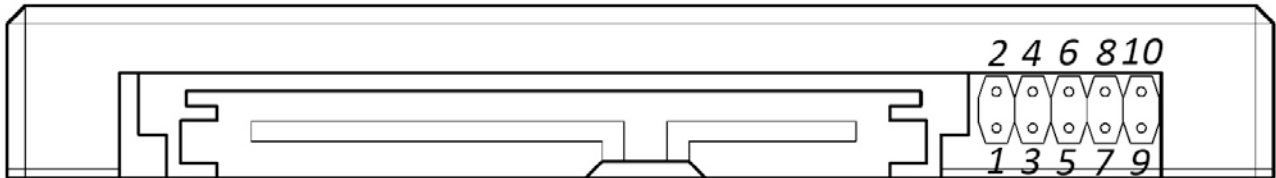

Figure 4 : The jumper configuration of 2.5" SATA III SLC SSD

#### 4.1.1. Default Setting

When security function is not required, jumper head should be placed on Pin-3 and Pin-5, SSD will not take any actions, it can be used as a normal storage device.

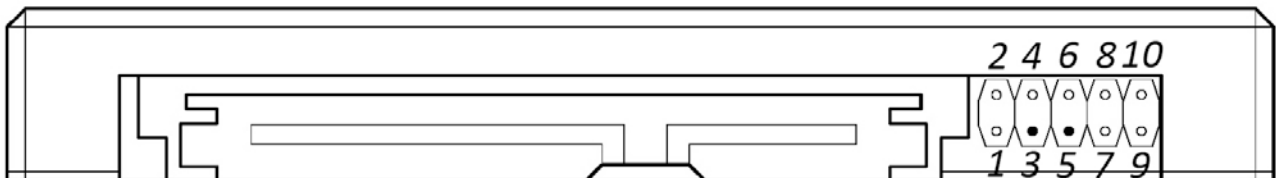

Figure 5 : Default Setting

#### 4.1.2. Write Protect Function

Write-Protect function can be enabled by setting the jumper head on Pin-3 and Pin-4, once it's enabled, it will abort any writing commands sent to the SSD. At this stage, SSD will become Read-Only and user will not be able to write or delete any data on the SSD.

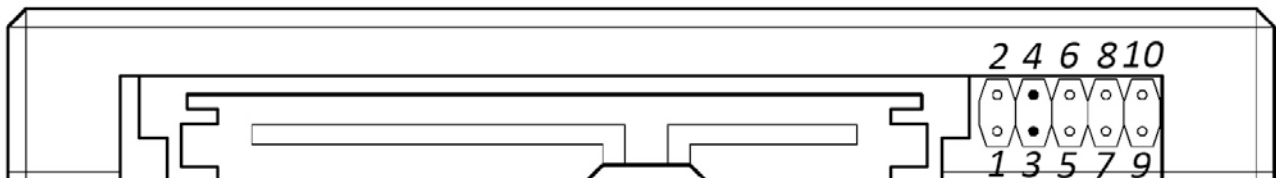

Figure 6 : Write-Protect Function Jumper Setting

### 4.1.3. Fast Erase

Fast Erase Procedure is one of the default sanitizing procedure in APRO Secure Erase SSD Series, it is trigger by placing jumper head on Pin-7 and Pin-8, SSD will be then become fully erased and filled with 0xFF and random data.

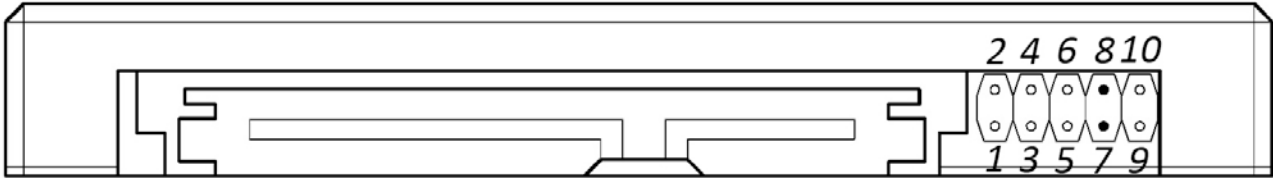

Figure 7 : Fast Erase Jumper Setting

### 4.1.4. Secure Erase

To execute Secure Erase function, jumper must be set on Pin-5 and Pin-6. APRO provide varieties of Secure Erase standard as options, customer may choose whichever is suitable for their application.

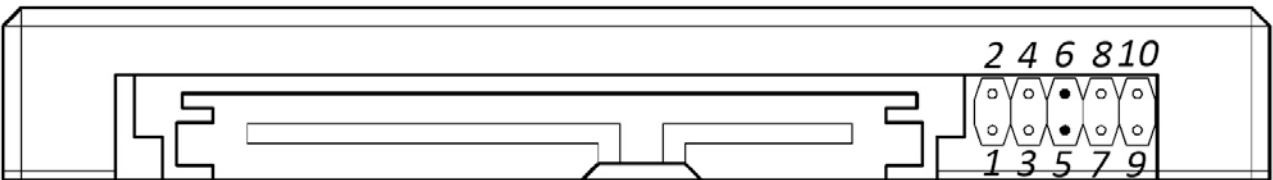

Figure 8 : Secure Erase Jumper Setting

#### 4.1.4.1. Secure Erase Standards

Table 7 – Secure Erase Procedures

Standard	Description
Fast Erase	Erase all media and fill with 0xFF and random data
NSA Manual 130-2	Erase the media and overwrite with random data twice, then erase again and overwrite with 0x55
USA-AF AFSSI 5020	Erase the media and overwrite with random data
DoD 5220.22-M	Erase the media and overwrite with single character, then erase again
IRIG 106	Erase the media, overwrite with 0x55, erase, overwrite with 0xAA, erase
USA Navy NAVSO P-5239-26	Erase the media, overwrite with random data, then erase again
USA-Army 380-19	Erase the media, overwrite with random data, fill with 0x55, overwrite again with 0xAA
NISPOMSUP Chap 8, Sect. 8-501	Filled with 0x55, overwrite with 0xAA, overwrite again with random data
NSA Manual 9-12	Erase the media, overwrite with unclassified pattern

### **4.2. Auto-Resume Features**

APRO industrial rugged metal 2.5" SATA III SSD – BON-II Series supports auto-resume features. When encounter power interruption during sanitizing procedure, it will automatically resume sanitizing at the next power-on until the whole procedure is finished.

### **4.3. Random Data Written During the Sanitize Procedure**

The random data used to overwrite user data is a digest of pseudo-random generation and real random data. The pseudo-random generation is seeded in such a manner that even if the SSD launches the Sanitize command under identical external conditions (for example, if the unit is powered on with Sanitize Interrupt active), it will produce different seeds and different pseudo-random data.

### **4.4. Protection Mechanism**

The protection mechanism only allows customer to activate Fast Erase and Secure Erase once for each power-on cycle. This is to protect APRO's SSD from being erased continuously and can indirectly extend the lifetime of flash. If user wishes to activate erase function again, power must be disconnect and then reconnect again.

### **4.5. Using the SSD After Sanitizing Procedure**

After Fast Erase or Secure Erase is finished, storage must be reinitialized and partition should be rebuilt in order to be used again.

## 5. Software Commands

### 5.1. Write Protect

Device will become Read-Only and user will not be able to write or delete any data on the SSD.

#### 5.1.1. Inputs for Enabling Write Protect

Table 8 – Input Write Protect Command Code (Enable)

Register	7	6	5	4	3	2	1	0
Features	17h							
Sector count	41h							
LBA Low	NA							
LBA Mid	NA							
LBA High	NA							
Device	1	1	1	0	NA			
Command	82h							

#### Outputs for Enabling Write Protect

Table 9 – Output Write Protect Command Code (Enable)

Register	7	6	5	4	3	2	1	0
Error	NA							
Sector count	NA							
LBA Low	NA							
LBA Mid	NA							
LBA High	NA							
Device	obs	NA	obs	DEV	NA	NA	NA	NA
Status	BSY	DRDY	DF	NA	DRQ	NA	NA	ERR

Device register

**DEV** - shall specify the selected device.

Status register

**BSY** - will be cleared to zero indicating command completion

**DRDY** - will be set to one.

**DF** (Device Fault) - will be cleared to zero.

**DRQ** - will be cleared to zero.

**ERR** - will be cleared to zero.



5.1.2. Inputs for Disabling Write Protect

Table 10 – Input Write Protect Command Code (Disable)

Register	7	6	5	4	3	2	1	0
Features	18h							
Sector count	41h							
LBA Low	NA							
LBA Mid	NA							
LBA High	NA							
Device	1	1	1	0	NA			
Command	82h							

5.1.2.1. Outputs for Disabling Write Protect

Table 11 – Output Write Protect Command Code (Disable)

Register	7	6	5	4	3	2	1	0
Error	NA							
Sector count	NA							
LBA Low	NA							
LBA Mid	NA							
LBA High	NA							
Device	obs	NA	obs	DEV	NA	NA	NA	NA
Status	BSY	DRDY	DF	NA	DRQ	NA	NA	ERR

Device register

**DEV** - shall specify the selected device.

Status register

**BSY** - will be cleared to zero indicating command completion

**DRDY** - will be set to one.

**DF** (Device Fault) - will be cleared to zero.

**DRQ** - will be cleared to zero.

**ERR** - will be cleared to zero.

## 5.2. Fast Erase

Below states the procedures of Fast Erase function.

- Erase all media.
- Fill with 0xFF.

### 5.2.1. Inputs for Enabling Fast Erase

Table 12 – Input Fast Erase Command Code (Enable)

Register	7	6	5	4	3	2	1	0
Features	21h							
Sector count	41h							
LBA Low	NA							
LBA Mid	NA							
LBA High	NA							
Device	1	1	1	0	NA			
Command	82h							

### 5.2.2. Outputs for Enabling Fast Erase

Table 13 – Output Fast Erase Command Code (Enable)

Register	7	6	5	4	3	2	1	0
Error	NA							
Sector count	NA							
LBA Low	NA							
LBA Mid	NA							
LBA High	NA							
Device	obs	NA	obs	DEV	NA	NA	NA	NA
Status	BSY	DRDY	DF	NA	DRQ	NA	NA	ERR

Device register

**DEV** - shall specify the selected device.

Status register

**BSY** - will be cleared to zero indicating command completion

**DRDY** - will be set to one.

**DF** (Device Fault) - will be cleared to zero.

**DRQ** - will be cleared to zero.

**ERR** - will be cleared to zero.

### 5.3. Secure Erase

#### 5.3.1. Identify Device Table

154	Secure Function Support	
	7-15 Reserved	O
	6 1=Secure Erase ATA Vendor Command Supported	X
	5 Reserved	O
	4 1=Fast Erase ATA Vendor Command Supported	X
	3 1=Reserved	X
	2 1= Jumper Secure Erase Supported	X
	1 1= Jumper Write Protect Supported	X
	0 1= Jumper Fast Erase Supported	X
155	Secure Function Status(Enable/Disable)	
	2-15 Reserved	
	1 1= Write Protect Enabled	X
	0 Reserved	O
156~158	Vendor Specific	
159	8~15	
	Function of Jumper "FE"	
	0x21 or Others: Fast Erase	
	0~7	
	Secure Erase Function of Jumper "SE"	
	0x22: AFFSI 5020	
	0x23: DoD 5220.22-M	
	0x24: USA Navy NAVSO P-5239-26	
	0x25: NSA Manual 130-2	
	0x26: USA-Army 380-19	
	0x27: NISPOMSUP Chap 8, Sect. 8-501	
	0x28: NSA Manual 9-12	
	0x29: IRIG106	
0x19: Get System Bad Block Data	XXXXh	

**5.3.2. NSA Manual 130-2**

Below lists the Secure Erase procedures of NSA Manual 130-2.

- Erase all media.
- Fill with random data twice.
- Erase all media.
- Fill with 0x55

**5.3.2.1. Inputs for Enabling NSA Manual 130-2**

**Table 14 – Input NSA Manual 130-2 Command Code (Enable)**

Register	7	6	5	4	3	2	1	0
Features	25h							
Sector count	41h							
LBA Low	NA							
LBA Mid	NA							
LBA High	NA							
Device	1	1	1	0	NA			
Command	82h							

**5.3.2.2. Outputs for Enabling NSA Manual 130-2**

**Table 15 – Output NSA Manual 130-2 Command Code (Enable)**

Register	7	6	5	4	3	2	1	0
Error	NA							
Sector count	NA							
LBA Low	NA							
LBA Mid	NA							
LBA High	NA							
Device	obs	NA	obs	DEV	NA	NA	NA	NA
Status	BSY	DRDY	DF	NA	DRQ	NA	NA	ERR

Device register

**DEV** - shall specify the selected device.

Status register

**BSY** - will be cleared to zero indicating command completion

**DRDY** - will be set to one.

**DF** (Device Fault) - will be cleared to zero.

**DRQ** - will be cleared to zero.

**ERR** - will be cleared to zero.

**5.3.3. USA-AF AFFSI 5020**

Below lists the Secure Erase procedures of USA-AF AFFSI 5020.

- Erase all media.
- Fill with random data.

**5.3.3.1. Inputs for Enabling USA-AF AFFSI 5020**

**Table 16 – Input USA-AF AFFSI 5020 Command Code (Enable)**

Register	7	6	5	4	3	2	1	0
Features	22h							
Sector count	41h							
LBA Low	NA							
LBA Mid	NA							
LBA High	NA							
Device	1	1	1	0	NA			
Command	82h							

**5.3.3.2. Outputs for Enabling USA-AF AFFSI 5020**

**Table 17 – Output USA-AF AFFSI 5020 Command Code (Enable)**

Register	7	6	5	4	3	2	1	0
Error	NA							
Sector count	NA							
LBA Low	NA							
LBA Mid	NA							
LBA High	NA							
Device	obs	NA	obs	DEV	NA	NA	NA	NA
Status	BSY	DRDY	DF	NA	DRQ	NA	NA	ERR

Device register

**DEV** - shall specify the selected device.

Status register

**BSY** - will be cleared to zero indicating command completion

**DRDY** - will be set to one.

**DF** (Device Fault) - will be cleared to zero.

**DRQ** - will be cleared to zero.

**ERR** - will be cleared to zero.

**5.3.4. DoD 5220.22-M**

Below lists the Secure Erase procedures of DoD 5220.22-M.

- Erase all media.
- Overwrite with random character.
- Erase all media.

**5.3.4.1. Inputs for Enabling DoD 5220.22-M**

**Table 18 – Input DoD 5220.22-M Command Code (Enable)**

Register	7	6	5	4	3	2	1	0
Features	23h							
Sector count	41h							
LBA Low	NA							
LBA Mid	NA							
LBA High	NA							
Device	1	1	1	0	NA			
Command	82h							

**5.3.4.2. Outputs for Enabling DoD 5220.22-M**

**Table 19 – Output DoD 5220.22-M Command Code (Enable)**

Register	7	6	5	4	3	2	1	0
Error	NA							
Sector count	NA							
LBA Low	NA							
LBA Mid	NA							
LBA High	NA							
Device	obs	NA	obs	DEV	NA	NA	NA	NA
Status	BSY	DRDY	DF	NA	DRQ	NA	NA	ERR

Device register

**DEV** - shall specify the selected device.

Status register

**BSY** - will be cleared to zero indicating command completion

**DRDY** - will be set to one.

**DF** (Device Fault) - will be cleared to zero.

**DRQ** - will be cleared to zero.

**ERR** - will be cleared to zero.

**5.3.5. IRIG 106**

Below lists the Secure Erase procedures of IRIG 106.

- Erase all media.
- Fill with 0x55.
- Erase all media.
- Fill with 0xAA.
- Erase all media.

**5.3.5.1. Inputs for Enabling IRIG 106**

**Table 20 – Input IRIG 106 Command Code (Enable)**

Register	7	6	5	4	3	2	1	0
Features	29h							
Sector count	41h							
LBA Low	NA							
LBA Mid	NA							
LBA High	NA							
Device	1	1	1	0	NA			
Command	82h							

**5.3.5.2. Outputs for Enabling IRIG 106**

**Table 21 – Output IRIG 106 Command Code (Enable)**

Register	7	6	5	4	3	2	1	0
Error	NA							
Sector count	Secure Erase Failure Block Number							
LBA Low	NA							
LBA Mid	NA							
LBA High	NA							
Device	obs	NA	obs	DEV	NA	NA	NA	NA
Status	BSY	DRDY	DF	NA	DRQ	NA	NA	ERR

Device register

**DEV** - shall specify the selected device.

Status register

**BSY** - will be cleared to zero indicating command completion

**DRDY** - will be set to one.

**DF** (Device Fault) - will be cleared to zero.

**DRQ** - will be cleared to zero.

**ERR** - will be cleared to zero.

**Sector Count** - The number of Erase Failure Block

**5.3.6. USA Navy NAVSO P-5239-26**

Below lists the Secure Erase procedures of USA Navy NAVSO P-5239-26.

- Erase all media.
- Overwrite with random data.
- Erase all media.

**5.3.6.1. Inputs for Enabling USA Navy NAVSO P-5239-26**

**Table 22 – Input USA Navy NAVSO P-5239-26 Command Code (Enable)**

Register	7	6	5	4	3	2	1	0
Features	24h							
Sector count	41h							
LBA Low	NA							
LBA Mid	NA							
LBA High	NA							
Device	1	1	1	0	NA			
Command	82h							

**5.3.6.2. Outputs for Enabling USA Navy NAVSO P-5239-26**

**Table 23 – Output USA Navy NAVSO P-5239-26 Command Code (Enable)**

Register	7	6	5	4	3	2	1	0
Error	NA							
Sector count	NA							
LBA Low	NA							
LBA Mid	NA							
LBA High	NA							
Device	obs	NA	obs	DEV	NA	NA	NA	NA
Status	BSY	DRDY	DF	NA	DRQ	NA	NA	ERR

Device register

**DEV** - shall specify the selected device.

Status register

**BSY** - will be cleared to zero indicating command completion

**DRDY** - will be set to one.

**DF** (Device Fault) - will be cleared to zero.

**DRQ** - will be cleared to zero.

**ERR** - will be cleared to zero.



### 5.3.7. USA-Army 380-19

Below lists the Secure Erase procedures of USA-Army 380-19.

- Erase all media.
- Overwrite with random data.
- Fill with 0x55.
- Fill with 0xAA

#### 5.3.7.1. Inputs for Enabling USA-Army 380-19

Table 24 – Input USA-Army 380-19 Command Code (Enable)

Register	7	6	5	4	3	2	1	0
Features	26h							
Sector count	41h							
LBA Low	NA							
LBA Mid	NA							
LBA High	NA							
Device	1	1	1	0	NA			
Command	82h							

#### 5.3.7.2. Outputs for Enabling USA-Army 380-19

Table 25 – Output USA-Army 380-19 Command Code (Enable)

Register	7	6	5	4	3	2	1	0
Error	NA							
Sector count	NA							
LBA Low	NA							
LBA Mid	NA							
LBA High	NA							
Device	obs	NA	obs	DEV	NA	NA	NA	NA
Status	BSY	DRDY	DF	NA	DRQ	NA	NA	ERR

Device register

**DEV** - shall specify the selected device.

Status register

**BSY** - will be cleared to zero indicating command completion

**DRDY** - will be set to one.

**DF** (Device Fault) - will be cleared to zero.

**DRQ** - will be cleared to zero.

**ERR** - will be cleared to zero.

**5.3.8. NISPOMSUP Chap 8, Sect. 8-501**

Below lists the Secure Erase procedures of NISPOMSUP Chap 8, Sect. 8-501.

- Fill with 0x55.
- Overwrite with 0xAA.
- Overwrite with random data.

**5.3.8.1. Inputs for Enabling NISPOMSUP Chap 8, Sect. 8-501**

**Table 26 – Input NISPOMSUP Chap 8, Sect. 8-501 Command Code (Enable)**

Register	7	6	5	4	3	2	1	0
Features	27h							
Sector count	41h							
LBA Low	NA							
LBA Mid	NA							
LBA High	NA							
Device	1	1	1	0	NA			
Command	82h							

**5.3.8.2. Outputs for Enabling NISPOMSUP Chap 8, Sect. 8-501**

**Table 27 – Output NISPOMSUP Chap 8, Sect. 8-501 Command Code (Enable)**

Register	7	6	5	4	3	2	1	0
Error	NA							
Sector count	NA							
LBA Low	NA							
LBA Mid	NA							
LBA High	NA							
Device	obs	NA	obs	DEV	NA	NA	NA	NA
Status	BSY	DRDY	DF	NA	DRQ	NA	NA	ERR

Device register

**DEV** - shall specify the selected device.

Status register

**BSY** - will be cleared to zero indicating command completion

**DRDY** - will be set to one.

**DF** (Device Fault) - will be cleared to zero.

**DRQ** - will be cleared to zero.

**ERR** - will be cleared to zero.

### 5.3.9. NSA Manual 9-12

Below lists the Secure Erase procedures of NSA Manual 9-12.

- Erase all media.
- Overwrite with unclassified pattern.

#### 5.3.9.1. Inputs for Enabling NSA Manual 9-12

Table 28 – Input NSA Manual 9-12 Command Code (Enable)

Register	7	6	5	4	3	2	1	0
Features	28h							
Sector count	41h							
LBA Low	NA							
LBA Mid	NA							
LBA High	NA							
Device	1	1	1	0	NA			
Command	82h							

#### 5.3.9.2. Outputs for Enabling NSA Manual 9-12

Table 29 – Output NSA Manual 9-12 Command Code (Enable)

Register	7	6	5	4	3	2	1	0
Error	NA							
Sector count	NA							
LBA Low	NA							
LBA Mid	NA							
LBA High	NA							
Device	obs	NA	obs	DEV	NA	NA	NA	NA
Status	BSY	DRDY	DF	NA	DRQ	NA	NA	ERR

Device register

**DEV** - shall specify the selected device.

Status register

**BSY** - will be cleared to zero indicating command completion

**DRDY** - will be set to one.

**DF** (Device Fault) - will be cleared to zero.

**DRQ** - will be cleared to zero.

**ERR** - will be cleared to zero.

## 6. Required Time for Secure Erase Function

Table 30 – Erase time for all standard and capacities

Command	Standard	8GB	16GB	32GB	64GB	128GB	256GB
21h	Fast Erase	8 secs	10 secs	11 secs	15 secs	17 secs	34 secs
22h	AFFSI 5020	10 mins	21 mins	21 mins	21 mins	23 mins	47 mins
23h	DoD 5220.22-M	1 min	2 mins	2 mins	3 mins	5 mins	10 mins
24h	USA Navy NAVSO P-5239-26	10 mins	21 mins	21 mins	21 mins	23 mins	47 mins
25h	NSA Manual 130-2	20 mins	44 mins	43 mins	45 mins	52 mins	105 mins
26h	USA-Army 380-19	12 mins	25 mins	25 mins	26 mins	34 mins	67 mins
27h	NISPOMSUP Chap 8, Sect. 8-501	11 mins	25 mins	25 mins	26 mins	33 mins	66 mins
28h	NSA Manual 9-12	1 min	2 mins	2 mins	3 mins	5 mins	10 mins
29h	IRIG 106	4 mins	7 mins	9 mins	13 mins	25 mins	50 mins

Note:

All erase times are listed based on minutes, tolerance level for each standard is within 60 seconds.

**Appendix A: Ordering Information**

**1. Part Number List**

◆ **APRO Rugged Metal 2.5" SATA III SLC SSD – BON-II Series**

Product Picture	Grade	Standard grade (0°C ~ 70°C)	Industrial Grade ( -40°C ~ +85°C )
	<b>8GB</b>	SR2SR008G-JHCTC-UFE(USE)	WR2SR008G-JHITI-UFE(USE)
	<b>16GB</b>	SR2SR016G-JHCTC-UFE(USE)	WR2SR016G-JHITI-UFE(USE)
	<b>32GB</b>	SR2SR032G-JHCTC-UFE(USE)	WR2SR032G-JHITI-UFE(USE)
	<b>64GB</b>	SR2SR064G-JHCTC-UFE(USE)	WR2SR064G-JHITI-UFE(USE)
	<b>128GB</b>	SR2SR128G-JHCTC-UFE(USE)	WR2SR128G-JHITI-UFE(USE)
	<b>256GB</b>	SR2SR256G-JHCTC-UFE(USE)	WR2SR256G-JHITI-UFE(USE)

**2. Part Number Decoder:**

**X1 X2 X3 X4 X5 X6 X7 X8 X9 – X11 X12 X13 X14 X15 – X16 X17 X18 C**

**X1** : Grade

**S**: Standard Grade – operating temp. 0° C ~ 70 ° C  
**W**: Wide Temp Grade- operating temp. -40° C ~ +85 ° C

**X2** : The material of case

**R** : 2.5" Rugged Metal Casing

**X3 X4 X5** : Product category

**2SR** : 2.5" SATA SSD w/SDRAM cache

**X6 X7 X8 X9** : Capacity

<b>008G:</b>	8GB	<b>064G:</b>	64GB
<b>016G:</b>	16GB	<b>128G:</b>	128GB
<b>032G:</b>	32GB	<b>256G:</b>	256GB

**X11** : Controller

**J** : JMicron (BON-II Series)

**X12** : Controller version

**A, B, C.....**

**X13** : Controller Grade

**C** : Commercial grade

**I** : Industrial grade

**X14** : Flash IC

**T** : Toshiba SLC-NAND Flash IC

**X15** : Flash IC grade / Type

**C** : Commercial grade

**I** : Industrial grade

**X16 X17 X18** : Special function

**UFE** : Fast Erase function only

**USE**: Secure Erase function (supported by special firmware) & Fast Erase function

**C** : Reserved for specific requirement

**C** : Conformal-coating

**Appendix B: Limited Warranty**

APRO warrants your Rugged Metal 2.5" SATA III SLC SSD against defects in material and workmanship for the life of the drive. The warranty is void in the case of misuse, accident, alteration, improper installation, misapplication or the result of unauthorized service or repair. The implied warranties of merchantability and fitness for a particular purpose, and all other warranties, expressed or implied, except as set forth in this warranty, shall not apply to the products delivered. In no event shall APRO be liable for any lost profits, lost savings or other incidental or consequential damages arising out of the use of, or inability to use, this product.

**BEFORE RETURNING PRODUCT, A RETURN MATERIAL AUTHORIZATION (RMA) MUST BE OBTAINED FROM APRO.**

Product shall be returned to APRO with shipping prepaid. If the product fails to conform based on customers' purchasing orders, APRO will reimburse customers for the transportation charges incurred.

**WARRANTY PERIOD:**

- SR2SRxxxG-JHCTC-UFE(USE) 3 years



- WR2SRxxxG-JHITI-UFE(USE) 5 years



**The warranty period is able to extend. Please contact APRO and/or Your APRO distributors for more information.**